

*CU-BUILT ENGINEERS PRIVATE LIMITED*



**CU-BUILT ENGINEERS PVT. LTD.**



**COMPANY PROFILE**  
**(Machine Division)**

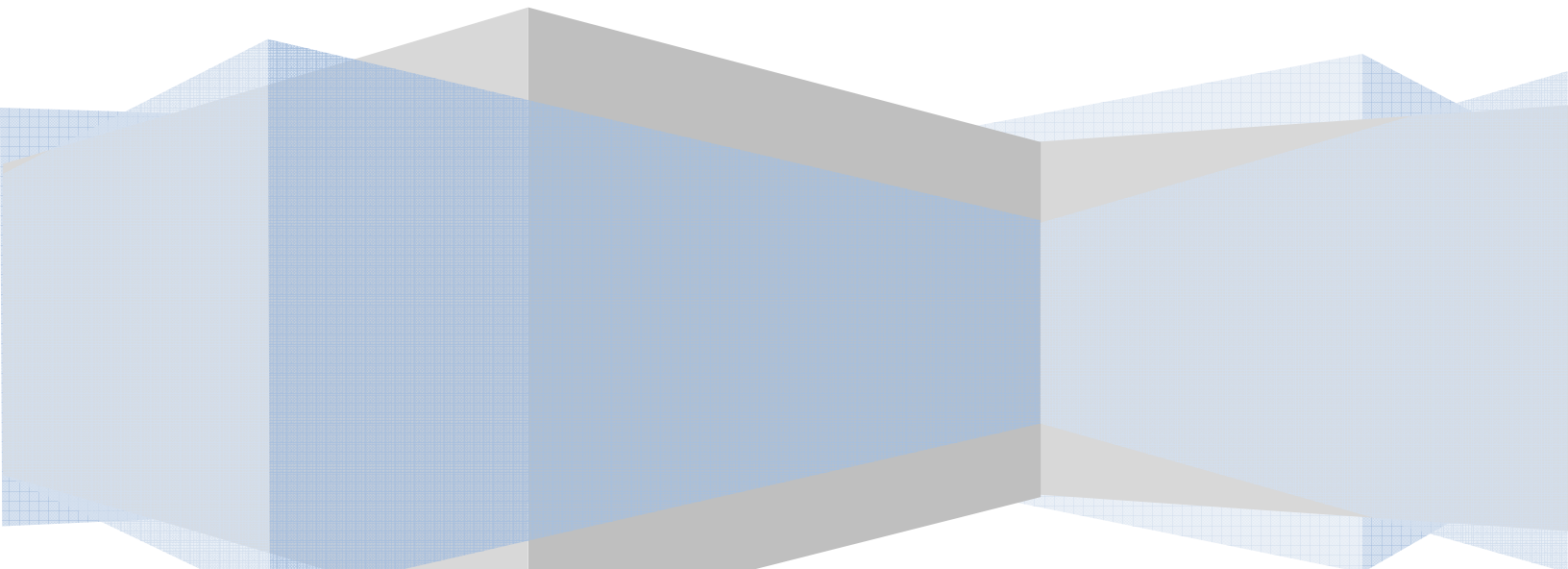

**MESSAGE FROM MD's DESK**

**Cu-Built Engineers Pvt Ltd** is an ISO 9001:2015 Certified company, incorporated in the year 1995. We are well known by our trade mark "Custom Built". We are pioneer in the field of Design, Manufacturing, Supply, Erection & Commissioning of the complete range of Welding Automation Systems, Special Purpose Machines, Industrial Cranes and Material Handling Systems.

Under the visionary guidance of our respected Managing Director Mr. P. S. Patil, we have attained distinguished position in the market. His vast domain expertise as well as business acumen have supported us in enlarging our operations globally.



**Mr. Pandurang S. Patil**  
**(Managing Director)**

Our foundation is strong considering some of our pillars in each and every field i.e. Production, Design, Marketing & After Sales Service. These pillars play role of backbone for the growth of our organization. The motto of our organization is to promote reliable After Sales Service too!

In Satara District of Maharashtra we started our Heavy Fabrication Unit 9 years back. Now we have 3000 MT Structural Fabrication Capacity per month in our existing capacity. We have a lot of equipments & machinery Facilities for Heavy Fabrication. Herewith we are attaching details of our available facility. We have 1,14,500 m<sup>2</sup> total land & 6,000 m<sup>2</sup> + 25000 m<sup>2</sup> Covered shed available at our Satara Works.

**COMPANY DOCUMENTS:**

- Certificate of Incorporation:
- PAN Card
- GST Certificate
- MSME / UAN Certificate
- ISO 9001:2015 Certificate
- CE Marking Certificate
- Organization Structure

**MANUFACTURING UNITS**



**Head Office and Manufacturing Unit 1 (Machining Facility)**

**Address:** Plot No. 149, Sector 10, PCNTDA, Bhosari, Pune - 411026, Maharashtra, India



**Unit 2 (Assembly Unit)**

**Address:** J-513/1/2, MIDC Bhosari, Pune - 411026, Maharashtra, India

**LIST OF MANUFACTURING FACILITY (BHOSARI, PUNE PLANT)**

**CU-BUILT ENGINEERS PRIVATE LIMITED**



Sr. No.	Description And Specification Of Machine And It's Make And Year Of Installation.	Accuracy And Finishing	No. of Machines Installed
1	30T OVER HEAD Crane - Cu-Built Make	SHEAD OF AREA 20000 SQ.FT WITH ELETRICITY LOAD OF 200 H.P. BOTH CRANE UNDER ONE ROOF.	1 No.
2	10T OVER HEAD Crane - Cu-Built Make		1 No.
3	Over Head Crane 5T Capacity Cu-Built Make With The Lift Of 8M. Installed On 2005	SHEAD OF AREA 5000 SQ.FT WITH ELETRICITY LOAD OF 30 H.P.	1 No.
4	Over Head Crane 7.5T Capacity Cu-Built Make Installed On 2002 With The Lift Of 10M.	SHEAD OF AREA 7500 SQ.FT WITH ELETRICITY LOAD OF 60 H.P.	1 No.
5	Welding Rectifier 400A. Advani Oerlikon Make, 1995 Installed On 1995	+ / - 20A As Per Setting Of Current welding Finish Good.	<b>4 No's</b>
6	Welding Rectifier 400A. Quality Engineering Baroda Make, 2004 Installed On 2004	+ / - 20A As Per Setting Of Current welding Finish Good.	5 No's
7	Welding Rectifier 400A Thyristorised. Memco Make, 2005 Installed On 2005	+ / - 10A As Per Setting Of Current welding Finish Good.	2 No's
8	Co <sub>2</sub> Welding Machine 400A. Advani Oerlikon Make, 1995 Installed On 1995	+ / - 10A As Per Setting Of Current welding Finish Good.	2 No's
9	Co <sub>2</sub> Welding Machine 400A. Essab Make, 2006 Installed On 2006	+ / - 10A As Per Setting Of Current welding Finish Good.	1 No.
10	Co <sub>2</sub> Welding Machine 400A. Sharp Make, 2006 Installed On 2006	+ / - 10A As Per Setting Of Current welding Finish Good.	8 No.
11	CNC GAS Cutting Machine PROARC Make	12000 x 3000mm cutting table	1 No.
12	Conventional Profile Cutting Machine 2000 mm Diameter. Installed On 2004.	Tolerance: Plus OR Minus 1 mm.	1 No.
13	Shot Blasting Booth.	4500 mm height * 3000 mm width * 6000 mm depth.	1 No.
14	Radial Drilling Machine CESPEL HUNGARY MAKE. 100 mm Drill Size.	Without Vibration Good Finishing. Accuracy 0.1-0.2mm	Total 1 No's
15	Radial Drilling Machine Prakash Make. 45 mm Drill Size. Installed On 2003, 2004 And 2005	Without Vibration Good Finishing Accuracy 0.2mm	Total 3 No's
16	Plano miller Between Column 2100 mm 10000 mm Clear Stroke, JAPAN Make 1985 Manufactured.	Without Vibration Good Finishing 0.05 mm Accuracy.	1 No.
17	Plano miller Between Column 2800 mm 8000 mm Clear Stroke, Italy Make 1980 Manufactured, Installed On 2005.	Without Vibration Good Finishing 0.05 mm Accuracy.	1 No.
18	Floor Boring machine COLLET USSR MAKE	6000 mm * 3000 mm 180 Spindle Accuracy 0.01-0.05mm	1 No.
19	Horizontal Boring Machine Spindle Size 100 mm Kansa Make Made In England. Year Of Manufacturing 1961 Installed On 2003	Without Vibration Good Finishing Accuracy 0.03 mm	1 No.
20	Horizontal Boring Machine Spindle Size 80 mm TOS	Without Vibration Good Finishing	1 No.

	Make Made In GERMANY Year Of Manufacturing 1971 .	Accuracy 0.03 mm	
21	VTL Richards Make ENGLAND	2500 mm diameter Swing. Accuracy 0.08mm	1 No.
22	7 Feet Lathe Machine Make Installed On 1995	Without Vibration Good Finishing Accuracy 0.02 mm	3 No.
23	TOS Make Lathe with DRO.	7 Feet Accuracy 0.01 micro	1 No.
24	Cylindrical Grinding Machine. TOS Make.	1200 mm between Center. Accuracy 1 micron	1 No.
25	Milling machine HMT Make	Accuracy 0.05mm	2 No's.
26	Brosh Drilling machine NIKKO Make.	50 and 100 mm capacity. Accuracy 0.01	1 No. each.
27	Air Compressor CHICAO Pneumatic Make	35 CFM	2 No's

**PORTABLE AND HAND MACHINES**

<b>Sr. No.</b>	<b>Description And Specification Of Machine And It's Make And Year Of Installation.</b>	<b>Accuracy And Finishing</b>	<b>Number Of Machines Installed</b>
1	Pug Cutting Machine Essab Make. 2002 Year Of Manufacturing And Installation.	Tolerance: Plus OR Minus 1 mm.	3 No.
2	Magnetic Drilling Machine. 36 mm Capacity. KPT Make Year Of Manufacturing And Installation 2004.	Tolerance: Plus OR Minus 0.5 mm.	2 No's
3	7 Inch Angle Grinder Bosch Make 1998		3 No's.
4	7 Inch Angle Grinder. KPT Make 2000		2 No's
5	7 Inch Angle Grinder. KPT Make 2004		3 No's
6	7 Inch Angle Grinder. KPT Make 2006		5 No.
7	4 Inch Angle Grinder. KPT Make 2003 And 2005		3 No's

**LIST OF MEASURING FACILITY / TESTING EQUIPMENTS AND INSPECTION FACILITY**

<b>Sr. No.</b>	<b>Description Of Equipment.</b>	<b>Size Range Capacity And Accuracy.</b>	<b>Make</b>
1	Vernier Caliper.	0 – 200 mm. L.C.0.02 mm.	Aerospace
2	Dial Vernier.	0 – 300 mm.L.m 0.01 Mm.	Mitutoyo
3	Micrometer Outside	0 – 25 / 25 – 50 / 50 – 75 / 75 – 100 / 75 - 200 mm With Accuracy Of 0.01 mm.	Mitutoyo
4	Micrometer Stick Type Inside	100 – 200 mm. 0.01 mm.	Mitutoyo
5	Bore Gauge.	25 – 150 mm. 0.01 mm.	Mitutoyo
6	Outside Caliper	0 – 300 mm 0.1 mm.	Apex
7	Inside Caliper.	0 – 300 mm 0.1 mm.	Apex
8	Steel Rule	200 / 300 / 1000 / 2000 Mm	Kristeel
9	Tong Tester Ac / Dc	Upto 2000A DC And AC 600 A.	LT Lutron
10	Hardness Testing Machine	DIGITAL	

**PRODUCTS:**



**Conventional Rotators**



**Self Centering Rotators**



**Self Aligning Rotators**



**Self Aligning Rotators**



**Self Aligning Rotators supplied in UK**



**Self Aligning Rotators supplied in UK**





**Press down Rotator**



**Press down Rotator**



**Conventional Rotator**



**Stand Rotator**



**Conventional Rotator**



**Conventional Rotator**



**Fit-Up Rotators**



**Fit-Up Rotators**



**Column and Boom**



**Telescopic Column and Boom**



**2 Axis Positioner**



**2 Axis Positioner**



**Head Stock with Idler Support**



**3 Axis Positioner**



**Hydraulic Positioner**



**Welding Gantry**



**Cladding SPM**



**PLC Controlled Integrated Welding SPM**



**Gantry Type SPM**



**Gantry Type SPM**

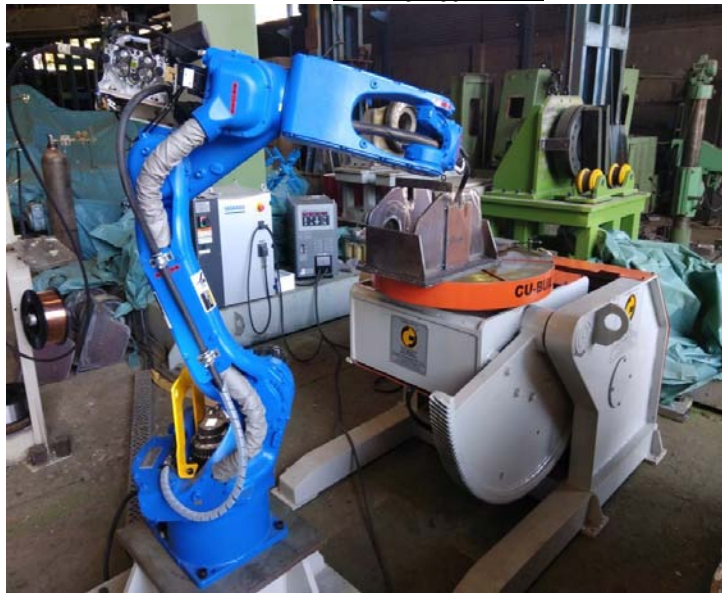

**Robotic SPM**



**Robotic SPM**



**HSTS Manipulators**



**2 Axis HSTS Manipulator supplied to Indian Coach Factory through Kuka Systems for Bogie Frame**

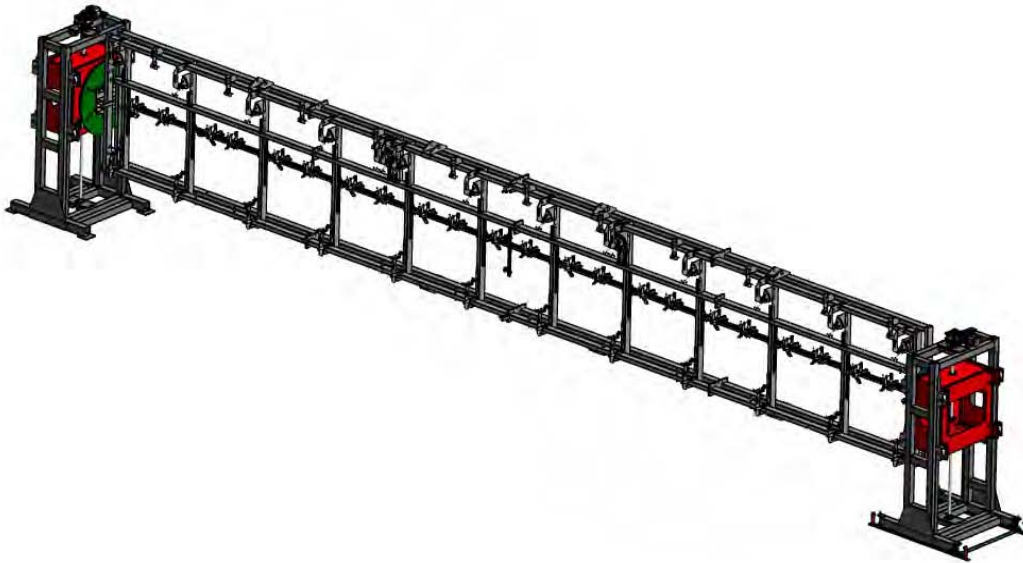

**10 Ton 2 Axis Manipulator for Side wall & Roof Beam supplied to ICF**

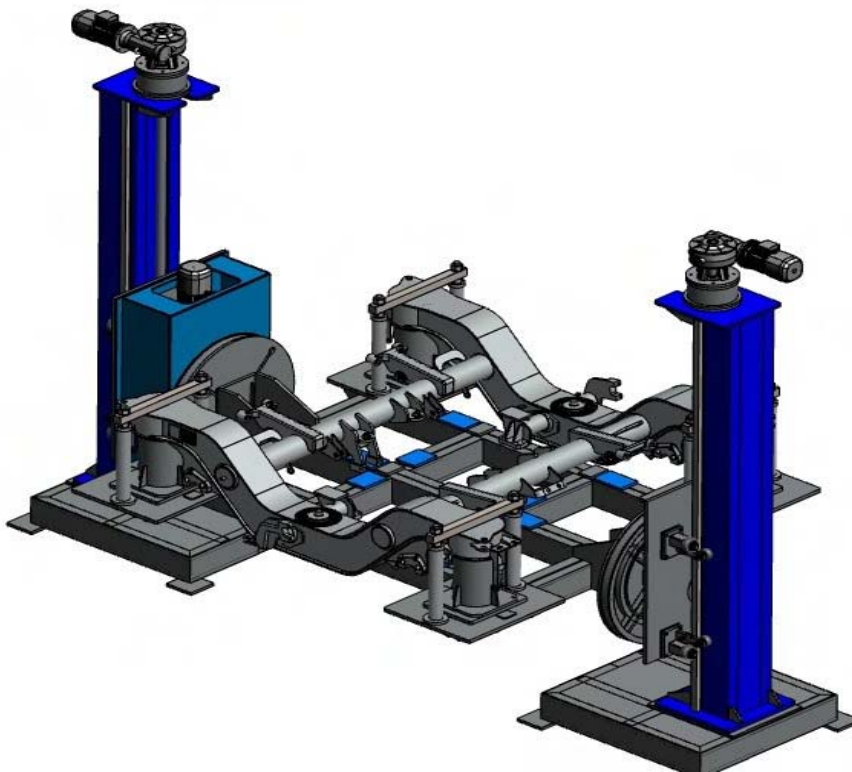

**5 Ton 2 Axis Manipulator for Bogie Frame supplied to ICF**

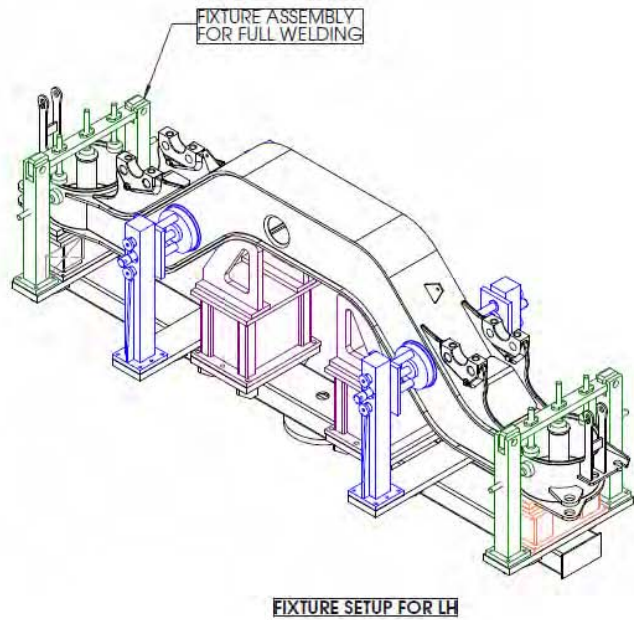
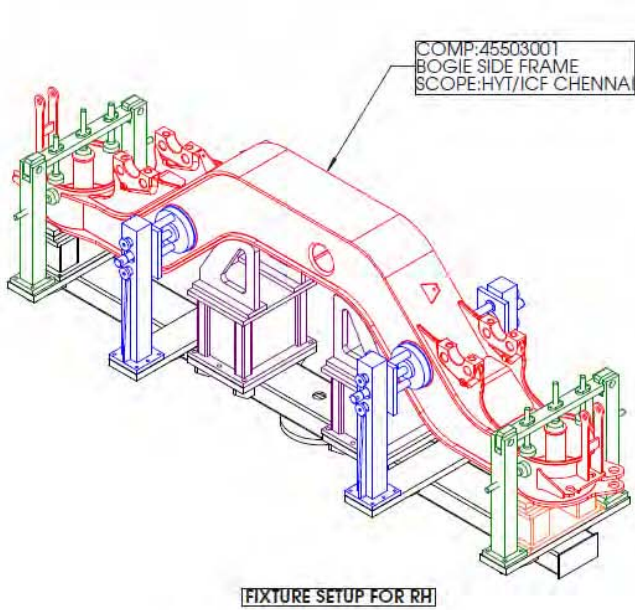

**Side Frame Full Welding Fixture**

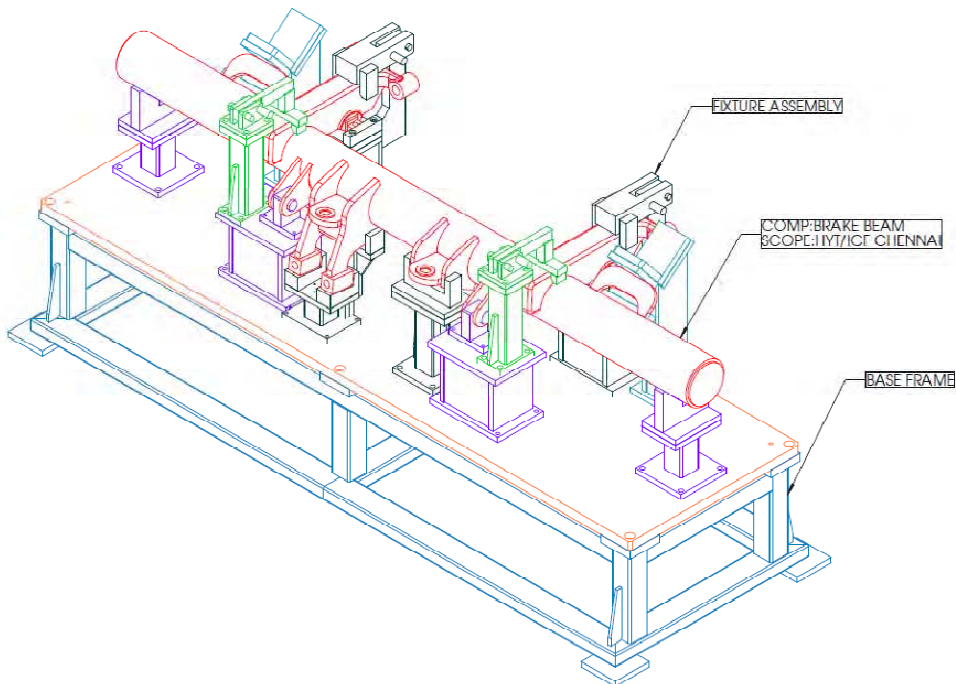

**Brake Beam Tack Weld Fixture**



**Dummy Bogies supplied to Alstom Transport for Metro Coaches**





**ID & OD Welding Gantry supplied to DLW through Amtek**



**Chassis Manipulator (10 Ton Capacity)**

**FABRICATION & MACHINING FACILITY**



CNC Gas Cutting Machine



CNC Plasma Cutting Machine



Plano Millers – 8 m and 10 m Length

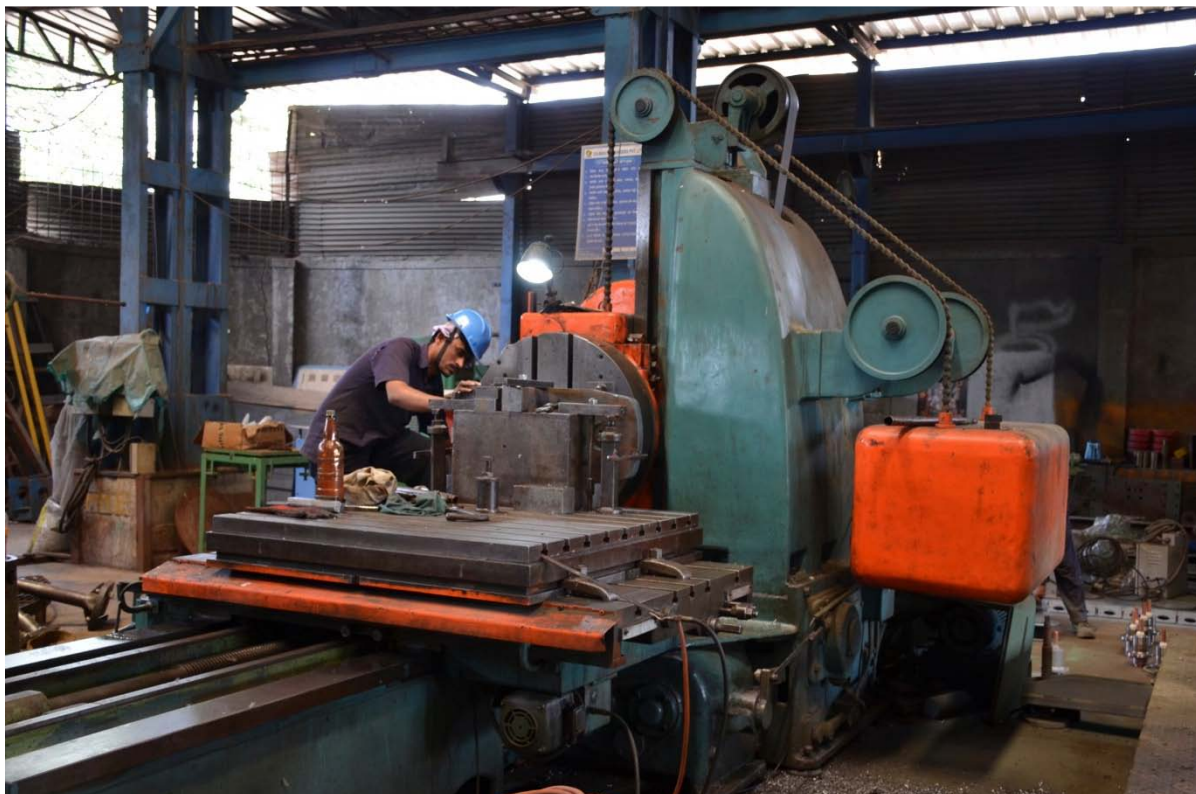

Boring Machines



Vertical Turning Lathe



Lathe Machines



Gear Hobbing Machines



Surface Grinding Machine



Hydraulic Press – 600 MT Capacity





CNC Press Brake Machine



Blasting Booths (3 Nos.)



Painting Booths – (5 Nos.)

**LIST OF CUSTOMERS (DOMESTIC)**

- 1 ABHInfrastructure
- 2 AdvaniOrelikon Ltd.PUNE.
- 3 AFAQ AL Khobar TradingEstablishment
- 4 Afcons InfrastructureLtd.
- 5 Anup Engineers, Ahmedabad
- 6 Adani Power,
- 7 Artson Engineering LimitedNashik
- 8 Udipi Power Corporation Limited
- 9 AKP Engineering Corporation Navimumbai
- 10 Alfa Laval India Ltd Mumbai -Pune Road. Dhapudi -Pune
- 11 Alstom Projects India Ltd.Shababad.
- 12 AMF Engineering PvtLtd
- 13 Ashoka Machine Tools Corporation D - 62 - 67, Site - V, Kasno Grater Noida - UP
- 14 Ashruly Engineering PvtLtd.
- 15 BakshiChempharmaEquipments Pvt. ltd.Mumbai.
- 16 Barakath Engineering Industries Pvt.Ltd.
- 17 BarakathIndustries
- 18 Bend Joints Pvt. Ltd. 42/43 A, Industrial Area, Govindpura,Bhopal.
- 19 BHEL BHOPAL.
- 20 BHELHaridwar
- 21 BHEL Hyderabad
- 22 BHEL TRICHY.
- 23 Bhilai Engineering CorporationLtd.
- 24 Calcom Cement India Ltd. - Pipalpukhuri, Khaki, Lanka Dist:- Nagaon -Assam
- 25 Camy Plants R-600,TTC Industrial Area, M.I.D.C., Rabale, NaviMumbai
- 26 CCMC
- 27 Cee Dee Vaccum Equipment Pvt.Ltd.
- 28 Chem Process SystemsPvt.Ltd
- 29 CJIndustries
- 30 Consolidated Chemequip (MFR) Corporation:- Thane - 421 203 (East)
- 31 Continent Projects TechnologiesPTE.Ltd.
- 32 Coperion Ideal Pvt.Ltd
- 33 DAS OFFSHORE ENGG. PVT. LTD, Rohini yard / Mumbai
- 34 DEC Engineering & Construction Pvt Ltd. Makarpura,Vadodara
- 35 Dee fabricomindiapvt ltdGujurat
- 36 DevibalaStructural
- 37 Dynaxcel Engineers Pvt Ltd. Pune
- 38 Diamond Fabrication (I) Pvt. Ltd. Bhosari,Pune
- 39 Dipesh Engineering Works 3, Sheroo Villa,, Andheri (W), Mumbai - 400053,
- 40 DN Wind Systems India Pvt. Ltd Tal HatkanangleDist .Kolhapur
- 41 DRD Trucks India Pvt.Ltd.
- 42 EaseweldEquipments (I) Pvt. Ltd. SakinakaMumbai.

## **CU-BUILT ENGINEERS PRIVATE LIMITED**



- 43 Engineers and Consultants Delhi
- 44 Expo Gas Containers Ltd Thane
- 45 Fabtech Works & Construction
- 46 Fabtech Works & Construction Pvt.Ltd.
- 47 Fedders Lloyd Corp.Ltd
- 48 Five Star Industries
- 49 Flash Point Equipemts Pvt. Ltd., PCNTDA Industrial Area, Bhosari, Pune - 411026.
- 50 Forbes Vyncke Pvt.Ltd
- 51 G.R.Engineering Pvt.Ltd.
- 52 Gas Tech Process Engineering (India) Pvt.Ltd.
- 53 Geecy Engineering Mumbai
- 54 Geecy Engineering Plot No. 33 - A, Mahape Post: Koparkaime, Navi Mumbai - 400709
- 55 Gemini Engg. Fab.Ltd.
- 56 GKAPS Engineering Industries
- 57 Global Gears India Pvt.Ltd
- 58 Global Wind Power Ltd
- 59 Godrej And Boyence Ltd.Mumbai
- 60 Gopinath Engineering Co. Pvt.Ltd.
- 61 Grasim Industries Ltd.Nagda.
- 62 HYT Engineering Pune
- 63 Harshada Industries
- 64 HDO
- 65 Hindustan Dorr - Oliver Ltd
- 66 Hypro Engineers, 238, 239 Sector No. 10, PCNTDA Bhosari, Pune – 411026.
- 67 IBP Co. LIMITED, (An Indian Oil Group Co.)
- 68 Indafab Projects Pvt.Ltd.
- 69 India Tube Mills & Metal Industries Ltd.
- 70 Indus Engineering Company
- 71 Indus Projects Ltd.
- 72 Industrial Manufacturers,
- 73 Inox Wind Ltd.
- 74 ISRO, India
- 75 ISGEC Dahej
- 76 ISGEC Yamunanagar
- 77 Ishan Equipments Pvt. Ltd. At. Ranoli, Vadodara
- 78 Jay Engineering Industries Tamilnadu
- 79 Jayaram Engineering Works
- 80 JVS Engineers Pvt.Ltd.
- 81 Kakinada Marine & Offshore Complex Ltd.
- 82 Kay Bouvet Engineering Pvt. Ltd. Satara
- 83 KBK Chem Engineering Pvt.Ltd
- 84 Kuka Systems India Pvt.Ltd
- 85 I & T EWACC MUMBAI
- 86 L & T Limited - Hazira, Surat

## ***CU-BUILT ENGINEERS PRIVATE LIMITED***



- 87 L&T Hydrocarbon Engineering Limited
- 88 Lalit Pipes & Pipes Limited, Dist :- Thane, Navi Mumbai
- 89 Larsen & Toubro Limited 101, GIDC Ranoli, Dist:- Vadodara - 391350
- 90 Likhita Energy Systems Pvt.Ltd.
- 91 Lincoln Electric Middle EastFZE
- 92 Lloyds Steel Industries Limited, Murbad,Thane
- 93 Master FabIndustries
- 94 MechEngineers
- 95 Meenakashi Associates (P) Ltd. Greater Noida, Dist.:- GautamBudhNagar
- 96 Metal Engineers - Unit V ThuvkudiTrichy
- 97 Metal Fab High Tech Pvt. Ltd. E-21-25, MIDC, Hingna Road, Nagpur – 440028
- 98 Metapow Engineers Pvt. Ltd. Bhosari,Pune
- 99 Mohammed N.M. Al-Baddah& Partner GeneralTrdg.
- 100 MultitexFiltration Engineers Ltd., New Delhi.
- 101 Nano-Mag Technologies Pvt.Ltd.
- 102 NTPCLimited
- 103 Nuberg EngineeringLimited
- 104 Omega-Kemix Pvt.Ltd.
- 105 Onshore Constructions Company Pvt.Ltd.
- 106 Optech Engineering PvtLtd.
- 107 Pan Gulf WeldingSolutions
- 108 Par Techno - Heat Pvt Ltd ahmedabad -382117
- 109 PavanEnterprises
- 110 Pinnacle Equipments.Pune.
- 111 Pinnacle InfrastructurePvt.Ltd.
- 112 Praj Industries Ltd. 748,Sansawadi, Pune - 412207
- 113 Praj Industries Ltd.Gujarat
- 114 Pratibha Pipes and Structural Pvt. Ltd. Mumbai (WADA)
- 115 Precision Storage VesselsPvt.Ltd.Dist.Tamilnadu,Tamilnadu
- 116 Premier Engineering &Equipments Mfg.Co.
- 117 PremierLtd.
- 118 Pressure Vessels(India)
- 119 Project Technologies Pvt. ltd.Baroda
- 120 Quality Engineering (Baroda) Pvt.Ltd.
- 121 Raj EngineeringCompany
- 122 Ratnamani Metals & Tubes Ltd
- 123 Ravi Industires, Talwade,Pune
- 124 RD Dynamech Infra Pvt. Ltd. OLD PadraRoad,Vadodara
- 125 Regen Power Tech Pvt.Ltd

- 126 RELIABLE HI-TECH INFRASTRUCTURE PVT.LTD.
- 127 RenergyEquipments India Pvt.Ltd
- 128 Richardson &Cruddas (1972)Ltd.
- 129 Rishi Projects Wind Miet Factory KadappaAndraPradesh
- 130 Shreevari Energy systems pvt ltd, Triruchirapalli
- 131 S. S. EnterprisesVapi
- 132 S.S. Fabricators & Manufacturers Plot No. K - 19, MIDC Hingna, Nagpur -16
- 133 Scorpio EngineeringPvt.Ltd. Bangalore
- 134 ShamrajEnerconTechnologies
- 135 Sharp Tanks &Structurals (P) Ltd J - 195, MIDC Industrial Area, Tarapur - 401506.
- 136 Shenik Industries. Jaysinghpur
- 137 Shree BalajiEngineering
- 138 Shreeji EngineeringMumbai
- 139 Siddhardha Engineering & ConstructionVisakhapatnam
- 140 Siddhyvinayak EnterprisesBanglore.
- 141 Sitson India Pvt. Ltd. Dombivali(East)
- 142 Skylark Precitech Pvt. Ltd. K - 20 / 21, MIDC., Kupwad, Dist:- Sangli - 416436
- 143 SoltrapSystems
- 144 SomFabricator
- 145 Sparklet Engineers Pvt.Ltd.
- 146 Sparkline Equipments Pvt.Ltd.
- 147 Sree Ramakrishna Engineering Enterpriese - Visakhapatnam
- 148 Sri Velmurugan Fabricators. - D - 68, Developed Plots Estate, Thuvakudi,Trichy
- 149 Steel Works & Power Engineers (P)Ltd.
- 150 SteelconTechnovision Pvt.Ltd.
- 151 Sukhamani Engineers Pvt.Ltd
- 152 Supertech Services Pvt.Ltd.
- 153 Surya Industrial Equipments,Hyderabad
- 154 Suzlon Structures Pvt.Ltd.
- 155 SCHWING Stetter (India) Private Limited, Chennai.
- 156 Techno Fab Mfg. Ltd. Anna Nagar West Extension,Chennai.
- 157 Tata Steel, KalinganagarOdisha
- 158 TEMA IndiaLtd.
- 159 Thermal Links ChikhaliPune
- 160 Thermax Babcock & Wilcox Energy Solutions Privatelimited
- 161 Thermopac Boilers Pvt.Ltd.
- 162 ThyssenKrupp Industries India Pvt. Ltd. Pimpri,Pune
- 163 Toolfab Engineering Industries (P) Ltd. No, Thuvakudi, Trichy - 620015
- 164 TrimurtiStainlinkEquipments Pvt.Ltd
- 165 Trio FabMumbai
- 166 UB EngineeringLimited
- 167 Unique ChemoplantEupmentAmbernath,Thane

- 168 Unitech MachinesLtd.
- 169 Universal Construction Machinery & Equipment Pvt.Ltd.
- 170 Universal Projects Chindwara(M.P.)
- 171 Vasudha EngineeringWorks
- 172 Veeru ConstructionCompany
- 173 Veasons Energy Systems Pvt. Ltd.Tiruchirapalli,
- 174 VR Coatings Pvt. Ltd.Pune
- 175 Velmurugan Heavy Engg. India Pvt. Ltd., ThuvakudiTrichy
- 176 VELMURUGAN HEAVY ENGINEERING INDUSTRIES PVT. LTD. UNITII
- 177 Vishal Nirmitti Pvt. Ltd. (GITAGROUP)
- 178 VitechEquipments Pvt. Ltd.Mumbai.
- 179 VMV ENGINEERING PVT.LTD.
- 180 Walchand NagarIndustries
- 181 Weldaids Pvt. Ltd. 1,Bangalore

**LIST OF CUSTOMERS (OVERSEAS)**

- 1 AL SAGHYIR BOILERS & PRESSURE VESSELS FACTORY CO. LTD. KSA
- 2 Afaq Al Khobar Trading Establishment SaudiArabia
- 3 Afi Industrial Equipment Factory, Industrial Equipment Factory, , SaudiArabia
- 4 AL-Julaiahpetroleum service co WLL
- 5 Al-Nisar Machinery. Doha QatarMr.AnilChakoo / Mr. ArunSawant.
- 6 Arabian Industries MUSCATOMAN
- 7 Arabian Industries Saudi
- 8 Best Oil & Gas Solution LLC, Sultanate ofOman
- 9 Consolidated Contractors INT's Co. DohaQatar
- 10 Danem Engineering Work JebelAlli
- 11 Dorman Long Engineering,Nigeria
- 12 Dresser-Rand-Arabia Ltd., SaudiArabia
- 13 EEW Group (Germany, Korea, Malaysia)
- 14 ESAB Middle East
- 15 Ferrofab FZC, Dubai
- 16 FabCon Industrial projects FZ Khaimah | UAE.
- 17 Ghantoot General Mechanical EngineeringDubai
- 18 Gulf Steel Works Saudi Arabia
- 19 Green Spring Group CO. W.L.L.,Kuwait
- 20 Hakuta Industry Equipment Joint StockCompany
- 21 HEISO KUWAIT
- 22 HWASHIN CO.LTD
- 23 Inma Steel SaudiArabia.
- 24 ISCO KUWAIT
- 25 Kuwait HeavyEngineering
- 26 Lincoln Electric Middle East FZC, Dubai,UAE
- 27 LMG RAIL CAR SDNBHD
- 28 M. H Al Mahroos KSA
- 29 Mohammed N. M. Al-Baddah& Partner General Trdg.,Kuwait

- 30 Mona Trading LLC, Dubai,UAE
- 31 NASH ENGINEERINGFZCO.
- 32 OMS Oilfield Services ArabiaLtd.
- 33 OysisDubai
- 34 PAN Gulf WeldingSolutions
- 35 Perfect International, Emirates. Sharajha.
- 36 Petrojet Egypt
- 37 Petron Emirates and Contracting LLC.Dubai.
- 38 PETRONASH FZEUAЕ
- 39 Qatar Welding & Fabrication Supplier WLL, DohaQatar
- 40 Red-D-Arc Limited,UK
- 41 Red-D-Arc Middle East, Dubai,UAE
- 42 RMA Middle East,Bahrain
- 43 SAGER,Columbia
- 44 ScomiOms Oilfield P.O. Box No. 117, Abqqiq SaudiArabia
- 45 Single Point Source Exports PvtLtd.
- 46 STS Clad LLC
- 47 Special Technical Services L.L.C., Sultanate ofOman
- 48 Speco Wind Power S.A. De C.V.Mexico
- 49 SPECO WIND POWER S.A. DE C.V.MEXICO
- 50 SteelWorksLtd. Bhutan
- 51 Universal Engineering Services LLC, Sultanate ofOman
- 52 Universal hi-tech (Dubai)
- 53 Velath Heavy Engineering, SharjahUAE
- 54 Welding Solution company middle east.

**LIST OF CUSTOMERS (FABRICATION DIVISION)**

- 1 GE Power India Ltd.
- 2 BHEL Trichy.
- 3 Forbes VynckePvt.Ltd
- 4 Inox WindLtd.
- 5 Suzlon StructuresLtd.
- 6 Thermax India Limited
- 7 Thyssenkrupp Industries India Pvt. Ltd. Pimpri,Pune
- 8 Walchand NagarIndustries
- 9 Wirtgen India PvtLtd
- 10 KirloskarPneumaticsLtd
- 11 Bgr Energy Systems PvtLtd
- 12 Bgr Boilers India PvtLtd
- 13 SiemensGamesa
- 14 Jssl,Dolvi



***CU-BUILT ENGINEERS PRIVATE LIMITED***



- 15 Ayoki Fabricators And ContractorsLlc
- 16 Regen Power Tech PvtLtd
- 17 Fives CailKcpLtd.
- 18 FurnaceFabrica
- 19 Chemdist,Pune
- 20 Kelvion India PvtLtd
- 21 Towell EngineeringLlc
- 22 ShapoorjiPallonji
- 23 DongyongMangaon
- 24 JSW, Dolvi